

CLUB CALL VK2AMW
VOLUME 08/02 ISSUED DECEMBER, 2005
NOW PRINTED MONTHLY
WORTH MORE THAN PETROL
MEETINGS HELD SECOND TUESDAY OF EACH MONTH (EXCEPT JANUARY).
S.E.S BUILDING MONTAGUE STREET, NTH WOLLONGONG. STARTING AT 7:30PM.
THE PROPAGATOR IS THE OFFICIAL NEWSLETTER OF
ILLAWARRA AMATEUR RADIO SOCIETY INC.
PO BOX 1838 WOLLONGONG 2500.
WEB PAGE - WWW.IARS.ORG.AU
E-MAIL- SECRETARY@IARS.ORG.AU
EDITOR- MAEVA BENNETT VK2HUG

EDITORIAL

Another year has flown by, time seems to go even more quickly these days. I don't know if it is a sign of getting older or that we are trying to cram more and more into our daily lives.

This year has been very eventful and a successful year for the Club, and has seen a whole raft of changes come into Amateur Radio with the introduction of the Foundation Licence and the restructuring of the Novice, Limited Novice, Limited, Restricted and the Unrestricted Licence Classes. We have met new friends from Fishers Ghost Club and re-established and maintained friendships with many both locally and internationally with IRLP.

Who ever said "retirement" is boring, obviously never retired!

This is the last issue of the Propagator for 2005, and I would like to thank all those who contributed to our magazine to make it an interesting read for all, without your help, I would not be able to do what I do each month.

I would also like to take this opportunity to thank my HAM (husband, amateur and mate), John. Without his support and assistance, I would never be able to do what I do and remain sort of sane.

To you and yours, from us and ours, may the festive season be a time of enjoyment, family, good food, company and conversation and may it continue on into 2006. May everything you wish for yourself and your family come true.

Merry Christmas and all the very best for 2006.

Maeva Bennett
VK2HUG
Editor.

THE ILLAWARRA AMATEUR RADIO SOCIETY INC EXECUTIVE AND COMMITTEE FOR 2006

President: Tony Stone VK2TS vk2ts@bigpond.net.au Ph 0404 839 465
Vice President: Rob McKnight VK2MT mcknightr@winns.com.au_ph: 0408 480630
Secretary: Maeva Bennett VK2HUG vk2aal@comcen.com.au ph: 4297 6065
Treasurer: John Lawer VK2KEJ ph: 4228 9856

Committee.

Geoff Howell VK2HIC (Public Relations and Publicity) vk2hic@nsw.chariot.net.au
Jack Desceso VK2XGD jack@newtek.com.au
Frank Diggle SWL
Boris Rewak VK2JJJ vk2jjj@tpg.com.au
Peter Reid VK2HPR vk2hpr@optusnet.com.au
John Bennett VK2AAL VK2HUG vk2aal@comcen.com.au ph: 4297 6065

Fund Raising Committee. Geoff Howell VK2HIC, Peter Reid VK2HPR and Jack Desceso VK2XGD

Editor. Maeva Bennett VK2HUG vk2aal@comcen.com.au

Publicity Officer. Geoff Howell VK2HIC

Membership secretary. John Bennett VK2AAL vk2aal@comcen.com.au ph: 4297 6065

Repeater Committee. Rob VK2MT, John VK2AAL

Canteen. Peter Reid VK2HPR.

Web Master. Michael Eckardt VK4GNV

December/Program for the Illawarra Amateur Radio Club

- Our last meeting for 2005 will be our 13th of December Meeting. The format of the Meeting will be a Presentation Night in recognition of our member's long term commitment to Amateur Radio and Christmas Party. Please remember to bring a plate for supper.
- We will be drawing our Christmas Hamper Raffle at the December Meeting. Please bring all ticket books and money to the Meeting or arrange to have it returned to the Club for the draw.
- The WIA broadcasts will be heard only on Sunday mornings during the Christmas Break and Geoff VK2HIC will be doing call backs as usual during the break.
- Our weekly Club broadcast will continue until the 20th December and will start again 7th February 2006.
- Our first meeting for 2006 will be the 14th February, Valentine's Day. Don't forget the flowers for your girl, or at least a card, the dogbox could be hot in February.

NEWTEK ELECTRONICS
Phone and Fax 4227 1620
RESELLER FOR
Altronics Arista Jaycar Avico
Stockists of: Alarm Accessories, UHF Antennae,
Tools, Computer Accessories, Test Equipment,
Cables, Plugs, RF Sprays and Components for the
Professional and the Amateur
Call in and see Jack at 345 Keira St., Wollongong



Stop The Press!!!!!!!!!!!!!!!

Club Members Special from Newtek for December

See Jack, there's a picture of him on the right in disguise,

Radio Remote Control using DTMF Circuit

Here is a circuit of a remote control unit which makes use of the radio frequency signals to control various electrical appliances. This remote control unit has 4 channels which can be easily extended to 12. This circuit differs from similar circuits in view of its simplicity and a totally different concept of generating the control signals. Usually remote control circuits make use of infrared light to transmit control signals. Their use is thus limited to a very confined area and line-of-sight. However, this circuit makes use of radio frequency to transmit the control signals and hence it can be used for control from almost anywhere in the house. Here we make use of DTMF (dual-tone multi frequency) signals (used in telephones to dial the digits) as the control codes. The DTMF tones are used for frequency modulation of the carrier. At the receiver unit, these frequency modulated signals are intercepted to obtain DTMF tones at the speaker terminals. This DTMF signal is connected to a DTMF-to-BCD converter whose BCD output is used to switch-on and switch-off various electrical appliances (4 in this case). The remote control transmitter consists of DTMF generator and an FM transmitter circuit. For generating the DTMF frequencies, a dedicated IC UM91214B (which is used as a dialler IC in telephone instruments) is used here. This IC requires 3 volts for its operation. This is provided by a simple zener diode voltage regulator which converts 9 volts into 3 volts for use by this IC. For its time base, it requires a quartz crystal of 3.58 MHz which is easily available from electronic component shops.

Pins 1 and 2 are used as chip select and DTMF mode select pins respectively. When the row and column pins (12 and 15) are shorted to each other, DTMF tones corresponding to digit 1 are output from its pin 7. Similarly, pins 13, 16 and 17 are additionally required to dial digits 2, 4 and 8. Rest of the pins of this IC may be left as they are. The output of IC1 is given to the input of this transmitter circuit which effectively frequency modulates the carrier and transmits it in the air. The carrier frequency is determined by coil L1 and trimmer capacitor VC1 (which may be adjusted for around 100MHz operation). An antenna of 10 to 15 cms (4 to 6 inches) length will be sufficient to provide adequate range. The antenna is also necessary because the transmitter unit has to be housed in a metallic cabinet to protect the frequency drift caused due to stray EM fields. Four key switches (DPST push-to-on spring loaded) are required to transmit the desired DTMF tones. The switches when pressed generate the specific tone pairs as well as provide power to the transmitter circuit simultaneously. This way when the transmitter unit is not in use it consumes no power at all and the battery lasts much longer. The receiver unit consists of an FM receiver (these days simple and inexpensive FM kits are readily available in the market which work exceptionally well), a DTMF-to-BCD converter and a flip-flop toggling latch section.

The frequency modulated DTMF signals are received by the FM receiver and the output (DTMF tones) are fed to the dedicated IC KT3170 which is a DTMF-to-BCD converter. This IC when fed with the DTMF tones gives corresponding BCD output; for example, when digit 1 is pressed, the output is 0001 and when digit 4 is pressed the output is 0100. This IC also requires a 3.58MHz crystal for its operation. The tone input is connected to its pin 2 and the BCD outputs are taken from pins 11 to 14 respectively. These outputs are fed to 4 individual 'D' flip-flop latches which have been converted into toggle flip-flops built around two CD4013B ICs. Whenever a digit is pressed, the receiver decodes it and gives a clock pulse which is used to toggle the corresponding flip-flop to the alternate state. The flip-flop output is used to drive a relay which in turn can latch or unlatch any electrical appliance. We can upgrade the circuit to control as many as 12 channels since IC UM91214B can generate 12 DTMF tones. For this purpose some modification has to be done in receiver unit and also in between IC2 and toggle flip-flop section in the receiver. A 4-to-16 lines demultiplexer (IC 74154) has to be used and the number of toggle flip-flops have also to be increased to 12 from the existing 4

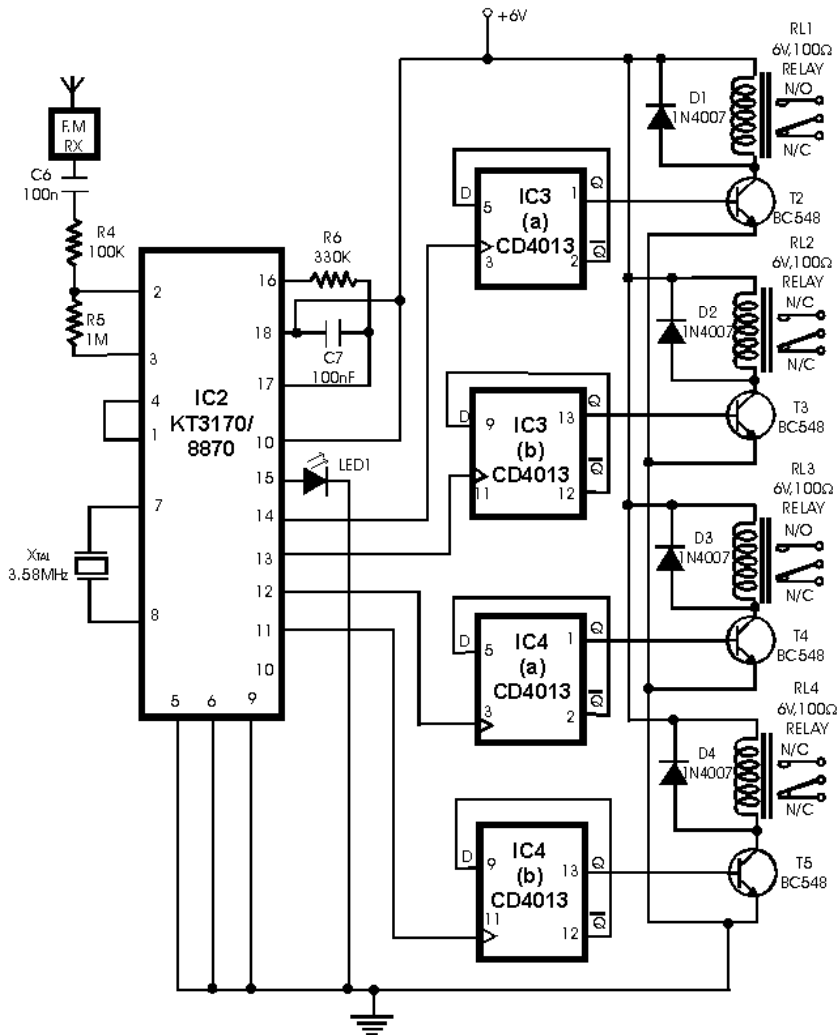
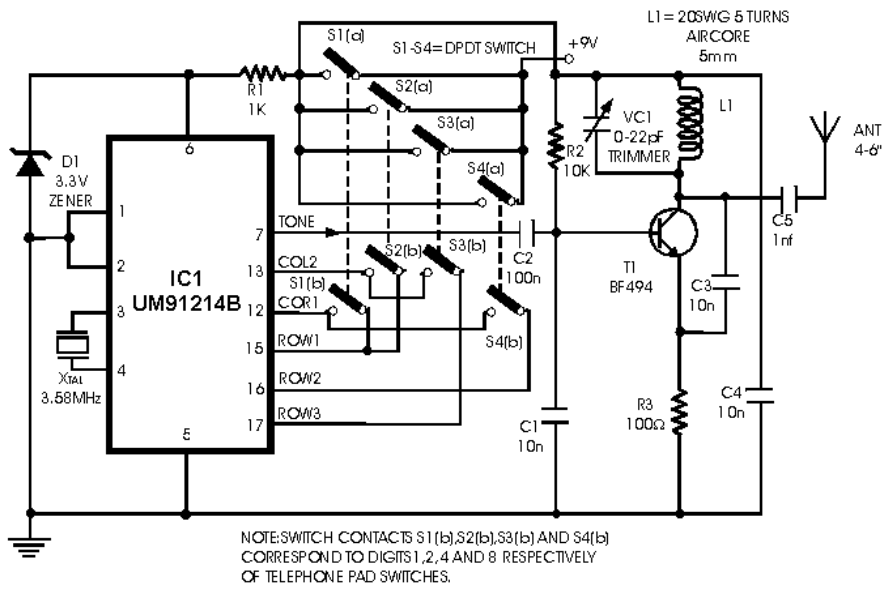



TOTAL CONCEPT PROJECTS

34-36 Adderley Street East, Silverwater NSW 2128 Phone 02 9648344

Total Concept Projects (Australia) Pty. Ltd. (TCP) is Australia's largest audiovisual integration company and has been providing professional services to specifiers and end user clients since 1984.

Our substantial experience has enabled us to develop a full range of services including consultation, design, and implementation of comprehensive audiovisual installations. Where necessary, we integrate and complement other industry specialists to skillfully complete high quality solutions.

With offices across Australia and in Malaysia; state and national borders do not stand in the way of our performance.

Recognised for high quality installations, our work with the latest in audio, video displays, specialised lighting, and automated control systems, can be viewed in major board rooms and conference rooms, 5 star hotels, registered clubs, auditoriums, entertainment venues, sporting stadiums and shopping centres around Australia and Malaysia.

TCP offers the solution for all audiovisual needs, including 24 hour, 7 day per week service and support.

Our in house resources include CAD design, sales engineering, project management, pre-fabrication, engineering, repair and testing technical services.

The expertise of our employees, our industry professionalism and product independence ensures that TCP can effectively fulfill any project's audio visual requirements from design to completion.

Good performance is not a matter of chance.

Recent clients include: Fuji Xerox, IBM, Star City, STDM Macau Tower Malaysia, City Recital Hall Angel Place, Melbourne Convention Centre, Gold Coast Convention Centre, Sydney Convention Centre, Subaru Docklands, Crown Casino, University of Technology Sydney, *Sydney Aquatic Centre...*

The technology Total Concept Projects use in their projects is amazing, here is a small sample of what they do. A visit to their web page www.totalconceptprojects is well worth the visit.

From simulated training rooms to lights dancing in the sky from a building top, to making your lounge room a treat in sight and sound, our experience with large and small projects prove there is no job too complex for the Total Concept Projects group.

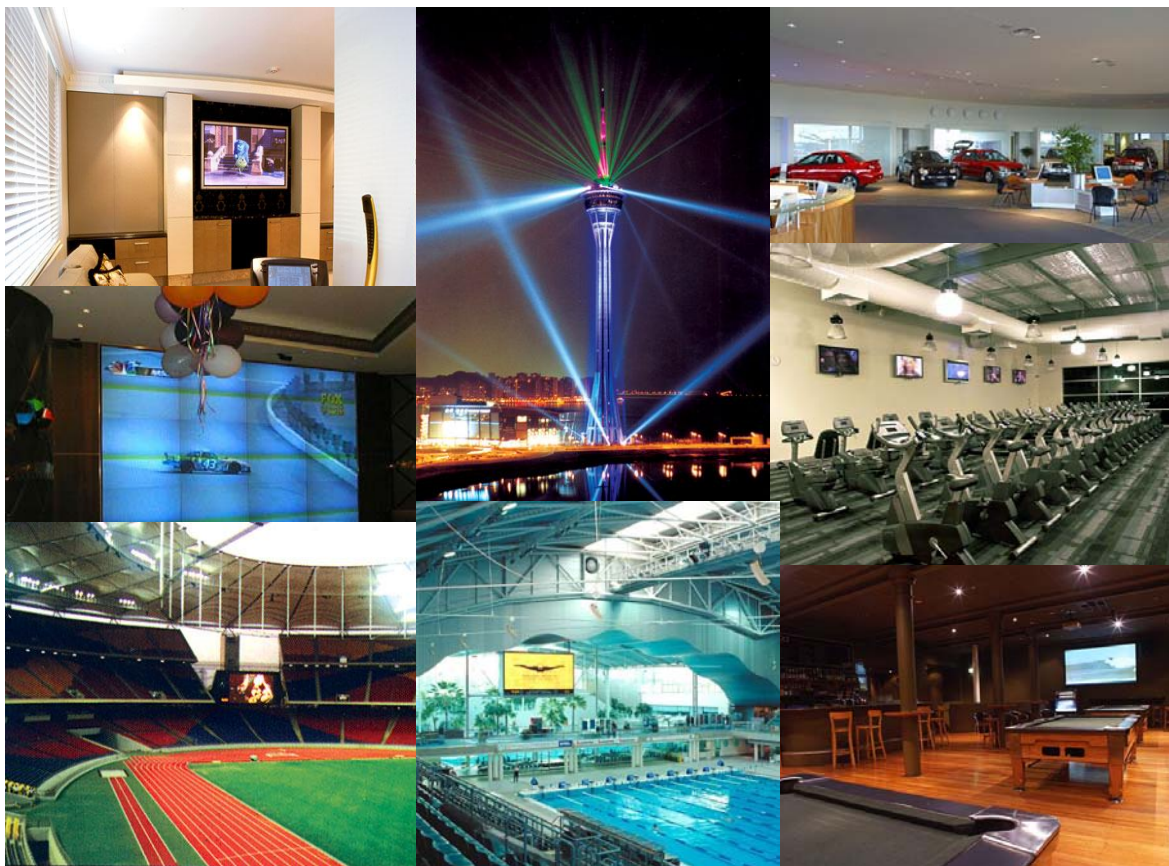

No Club would survive without the help of others, grateful thank you's must go to Richard Skarzynski and Phil Greaves VK2ZZY and Total Concept Projects for their very generous donation of a 30 inch LCD TV and DVD recorder to our Club to raise funds to keeps us on the air. The TV and the DVD player will be raffled by our Club, with ticket sales starting in February, 2006.

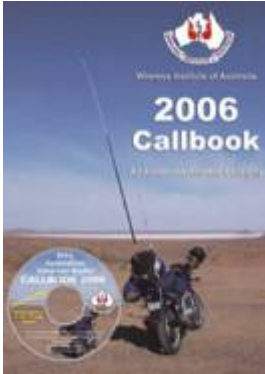

The 2006 WIA Callbook will soon be available.

If you are interested in purchasing a copy, please let the Secretary know so they can be ordered.

For our members to gain a saving on postage etc, there is a minimum number order required.

The cost will be approximately \$25.00 per copy if we order in bulk.

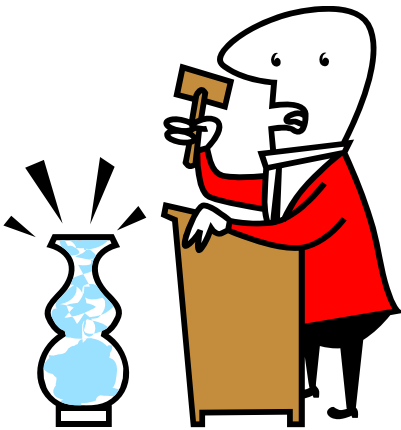

Our Auction Night

Our annual Auction Night was held after the November Meeting, I have never seen such a short brief General Meeting. It was 7 minutes, I think it is a record. I am sure members and visitors wanted to see all the bargains, the trash and the treasure.

Simon VK2XQX, was once again our auctioneer with the mostest – that is getting the maximum bid for all, including pitching father against son, at stages.

It was our largest attendance at a Meeting for some time, with President of the Fisher's Ghost Club Wal, VK2ZWK and his wife, Lynn, and members of the Mid South Coast Club also attending.

Bidding was brisk and lively, with items ranging from a headset radio, fax machine, to handheld radios, power supplies, test gear and speakers. If an item wasn't sold, it was added to the next lot to be auctioned, giving 2 for the price of 1 and a real bargain to many. I am sure Jack will be hurting in the wallet department for a while, his son, Andrew, had great fun trying to outbid Dad and on several occasions outbid him!

The Club coffers showed a good profit on the night of \$330.20, earned by commission and the selling of surplus Club equipment.

To organize such a night many thanks need to be said:-

1. To Simon, without you, well, the Auction would not have been the same, your insight, humour, knowledge and skill with the hammer are legendary.
2. To our President, Tony, who spent many hours designing the auction forms and attending to the detail of matching the items and the sale list, so things were co-ordinated.
3. To our Treasurer, John Lawer, who kept track of the sales and collecting the money and might I say, balancing! His pencil became several millimeters shorter – again!
4. To our runners, Geoff Howell and John Bennett, who ended up with sore feet and legs, who needs the gym!
5. To Jack Decesco, who made sure each item that was sold was displayed in the correct order.
6. And to Peter Reid, who made sure there was drinks and bickies after the auction, so members could talk, examine their purchases, and bemoan about the bargain that got away.

And finally to you the members, who brought your trash and your surplus items to the Auction and then your money to purchase – without you there would not have been a good Auction and a fun night for all.

Name Badges

The Committee has negotiated with Perfection Badges a wonderful deal to purchase name badges for our members.

The cost of the badges will be \$13.00. Each badge will contain the Club logo and name, your name and call sign.

If you wish to purchase a name badge, please complete the order form below and send it to the Secretary, IARS Inc, PO Box 1838 Wollongong NSW 2500 with your payment or alternatively come to the December Meeting and fill in an order form there. Forms are also available from the Club webpage, www.iars.org.au.

A concept of the badge is below. Note it is not to scale, the badge will be resin coated with an attachment pin, if you want a magnetic pin instead, it will be an additional \$2.00.

Your name badge will be at the following Meeting that your order it.

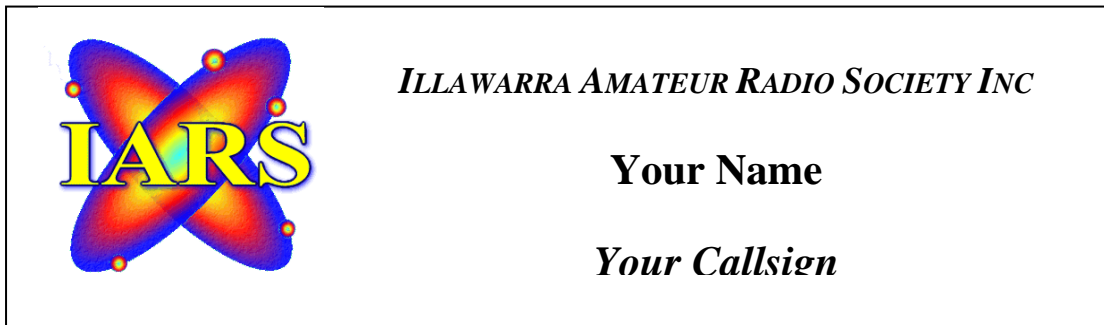

Name Badge Order form

Name Badges are \$13.00 each

Name _____

Call sign _____

Magnetic Attachment at an additional \$2.00 _____

I have enclosed my payment of \$ _____

Signature _____

Office Use

Payment Made.....Date.....

Badge Ordered.....Date.....

Badge Given to Member.....Date.....



IARS Christmas Raffle

Tickets \$1 each or 3 for \$2.00
ON SALE NOW!





Help your club keep financial and you on the air

All members are asked to contribute non perishable goods

Please ask the fundraising committee for a book of tickets to sell to your family, friends and workmates.

It will be drawn at the December Meeting.

December 2005

<u>Sunday</u>	<u>Monday</u>	<u>Tuesday</u>	<u>Wednesday</u>	<u>Thursday</u>	<u>Friday</u>	<u>Saturday</u>
				1 The Propagator is on the Web Page	2	3
4	5	6	7	8	9	10
11	12	13 IARS Club Meeting Presentations Christmas Party	14	15	16	17
18	19	20 Last Broadcast for the year	21 IARS Committee Meeting	22	23	24
25 Christmas Day 	26 Boxing Day 	27 Public Holiday 	28	29	30	31 New Years Eve 



2005 Presentation Night and Christmas Party
Tuesday, 13th December 2005

Presentation of Certificates of Participation in Amateur Radio:
to recognise the contribution of individual operators to Amateur Radio
and the Illawarra Amateur Radio Society.

Christmas Supper and Final Chin-wag for 2005



The Funnies

Very interesting.....

Year 1981

- 1.Prince Charles got married
2. Liverpool crowned Champions of Europe
3. Australia lost the Ashes
4. Pope Died

Year 2005

1. Prince Charles got married (again)
2. Liverpool crowned Champions of Europe (again)
3. Australia lost the Ashes
4. Pope Died

In future, if Prince Charles decides to re-marry and Liverpool wins another European crown.... please warn the Pope...

GRAND AVENUE

BY STEVE BREEN



© 2005 UFS, Inc.

I feel like my body has gotten totally out of shape, so I got my doctor's permission to join a fitness club and start exercising. I decided to take an aerobics class for seniors. I bent, twisted, gyrated, jumped up and down, and perspired for an hour. But, by the time I got my leotards on, the class was over.

Reporters interviewing a 104-year-old woman: "And what do you think is the best thing about being 104?" the reporter asked. She simply replied, "No peer pressure."

The nice thing about being senile is you can hide your own Easter eggs.

Just before the funeral services, the undertaker came up to the very elderly widow and asked, "How old was your husband?" "98," she replied. "Two years older than me." "So you're 96," the undertaker commented. She responded, "Hardly worth going home is it?"

I've sure gotten old. I've had two bypass surgeries, a hip replacement, new knees. Fought prostate cancer and diabetes. I'm half blind, can't hear anything quieter than a jet engine, take 40 different medications that make me dizzy, winded, and subject to blackouts. Have bouts with dementia. Have poor circulation; hardly feel my hands and feet anymore. Can't remember if I'm 85 or 92. Have lost all my friends. But, thank God, I still have my driver's license...

Know how to prevent sagging? Just eat till the wrinkles fill out.

These days about half the stuff in my shopping cart says, "For fast relief."

THE SENILITY PRAYER

Grant me the senility to forget the people I never liked anyway, the good fortune to run into the ones I do, and the eyesight to tell the difference.

A husband was in big trouble when he forgot his wedding anniversary. His wife told him "Tomorrow there better be something in the driveway for me that goes zero to 200 in 2 seconds flat."

The next morning the wife found a small package in the driveway. She opened it and found a set of brand new bathroom scales.

Funeral arrangements for the husband have been set for Saturday.

HAZARDOUS MATERIALS DATA SHEET	
ELEMENT:	Woman
SYMBOL:	♀
DISCOVERER:	Adam
ATOMIC MASS:	Accepted as 55kg, but known to vary from 45kg to 225kg
PHYSICAL PROPERTIES	
1. Body surface normally covered with film of powder and paint	
2. Boils at absolutely nothing – freezes for no apparent reason	
3. Found in various grades ranging from virgin material to common ore	
CHEMICAL PROPERTIES	
1. Reacts well to gold, platinum and all precious stones	
2. Explodes spontaneously without reason or warning	
3. The most powerful money reducing agent known to man	
COMMON USE	
1. Highly ornamental, especially in sports cars	
2. Can greatly aid relaxation	
3. Can be a very effective cleaning agent	
HAZARDS	
1. Turns green when placed alongside a superior specimen	
2. Possession of more than one is possible but specimens must never make eye contact	

Conference of Club



This year's Conference of NSW and ACT Clubs was held on the 19th November at WIA House at Parramatta and hosted by ARNSW and WIA National.

Our Club was represented by Rob McKnight, VK2MT, and John Bennett, VK2AAL.

As the Conference started at 9.00am it was an early start to drive to Parramatta, and surprise surprise, they arrived on time!



Over 20 people attended the Conference, which was addressed by ARNSW President Chris Devery VK2XCD and WIA President Michael Owen VK3KI.

The WIA office, we were told, is having a problem processing the Foundation Licence and may require additional staff and it was stated that more examiners for the Foundation Licence were needed, but now time was given as to when this might take place.



John Gibling VK2EKG provided a presentation on working with young people. Also discussed were the legal requirements and checks required to work with younger learners.

The National and State broadcast content and format were discussed, and it was decided that the National Broadcast would be hard to improve on, but the NSWAR broadcast could do with a new format, maybe, multiple broadcasters and shorter

in length. Tim, VK2ZTM, said there was no internet connection at Dural and that they were looking to automate the broadcast in the future with internet connection.

ARNSW has decided to put deceased estate equipment up for tender on their webpage, rather than handled as it has been in the past, to prevent dealers from purchasing the equipment to be sold at a profit on sites like ebay etc.

ARNSW is to be thanked for putting the Conference on and providing their facilities and refreshments for those who attended. It was greatly appreciated by all.

While at the meeting, 3 copies of the Foundation Licence Manual were purchased on behalf of our Club.

John Bennett
VK2AAL

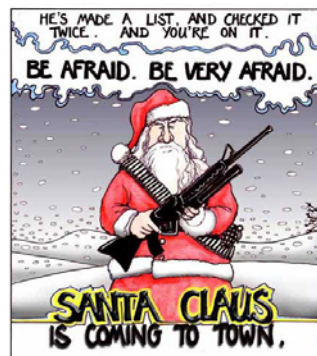



Presidents Report for November 2005.

Here we all are at the end of another year; doesn't time seem to accelerate as we **all** are getting older!

I'd like to take this opportunity to thank all the members of the committee for their efforts and to the club members who always seem to attend our club meetings. Can anyone guess who one of these mystery club members who always seemed to attend is? This member used to regularly sell the raffle tickets for the IARS back in the 70's when the club meetings were held in the old Wollongong Town Hall and the old NES hall (I think the name is right). He used to use the catch phrase "everyone's a winner". Let me know if you think you know who it is, at the December meeting ☺

To those club members who haven't been to recent meetings it would be nice to see you a bit more regularly. Remember there is the lucky door prize and snowball each month and it may well be **you** who wins this month. If you aren't at the meeting when the prize is drawn then you won't win the prize. Besides that, the meetings are great fun, and the rag chew afterwards even better. Remember this month's Christmas meeting is the last club meeting for the year until February 2006, so your attendance would be greatly appreciated!

A list of specific thank you's must go to the following IARS members:

- Simon VK2XQX – Last month's Auction wouldn't have been the same without you Simon, you certainly worked yourself into a sweat ☺ I think we had better invite Jack's son against next year as he helped things along even bidding against Jack at times ☺
- Geoff VK2HIC and Jack VK2XGD – The broadcasts are very entertaining and I fear our resident DJ's may be snapped up by the local radio stations if we aren't careful. Geoff tirelessly appears every Sunday morning and evening to take callbacks and the listening audience had grown to a very respectable level. Just a reminder that Geoff and Jack will be taking a well earned rest from the club broadcasts and callbacks to recharge their batteries and will recommence early next year.
- Maeva – VK2HUG – Maeva, you have certainly come up with some great ideas and implemented them in a way that only you could implement them. The propagator is an absolute credit to you. I could only imagine the amount of effort to assemble it every month. Watch out for the Wyong Field day in February next year, Maeva 2HUG is coming your way!!!
- John VK2AAL and Rob VK2MT – Guys the repeater system is an outstanding effort for an amateur radio club. Even Commercial companies operating trunked radio systems don't come close to the facilities and features offered by the IARS system. I am glad to see the IRLP node 6018 is also getting used more and more regularly.
- John Lawer – VK2KEJ (See John I spelt your last name correctly this time). I think we should call John, BP – the quiet achiever. He plugs away with his receipt book at every meeting and behind the scenes and never complains about things. He always thinks of the club's best intentions and never misses a cent. THANK YOU JOHN!
- Peter VK2HPR – Mate, the coffee and bickies are always good and the rag chew wouldn't be the same without it.

If I have forgotten to list you above I apologise in advance.

Let me take this opportunity to thank you the members for all your support and extend the very best greetings for the festive season and New Year. Please play it safe, especially over the festive season, so that we can see you all next year.

73's and cheers

Tony Stone

VK2TS

President – IARS Inc

From the Secretary's Desk



This year I have been getting a lot of emails from various places, be they a note from a friend, a joke, information or a scam – I get a lot of these so called get rich quick schemes. The Internet has changed the way we communicate with each other locally, nationally and internationally. Amateur radio also has the same capacity, locally – simplex, nationally through a repeater and internationally by IRLP. There are also various other ways we can communicate with each other on the ham network – Echolink, VOIP and many others. We can use our internet browsers to find out any information we might need and information on any Amateur Radio Club through out the world.

The internet has changed the way we do things forever. We can now pay our bills using Bpay, write to a friend, talk to a friend and find new friends, find out any information we need, buy anything we need, all through a touch of a key. The world is truly our oyster – the boundaries are disappearing rapidly. I can purchase an item in the UK and it can be paid for and delivered within a few weeks – sometimes quicker than a delivery for a local supplier.

Life is getting easier for all but what are the consequences?

Newspaper sales have dropped considerably, why purchase a newspaper when you can get the latest, from a news site, we can save a few trees that way too. Books and encyclopaedias are now almost redundant, by the time something is published, it is out of date – the world is changing so rapidly and new discoveries are being made every day making much of the previously published information obsolete or false.

Charity no longer starts at home – its now on a global scale with multimillion dollar organisations making decisions on how and where the dollars are to be spent and how much. You always let the phone ring at least 6 times now to avoid a call centre trying to get you to donate or buy something, especially around 6.00pm.

In all of the new technology the little person, the individual, is missing. We deal with faceless people who we never meet, or shake their hand. Personal contact is missing – the art of relating to people and individual need is dying for the betterment of the large group. But is the individual being sacrificed?

The same can be said in our little radio society. Membership to local radio clubs is dropping rapidly, it's not just in Australia but an international concern. Most organisations report that the number of volunteers is dropping alarmingly. Is it because the world expects more from us or is it because our society is now geared around making a profit?

In the scale of the universe we are only a little Club, we are of little consequence to the scheme of things or are we? Our Club definitely does not make a profit, our members are constantly asked to put their hand in their pocket for a few cents to keep us running. We operate the largest area with our 5 repeaters, which are available for everyone to use, club member or not. Without our repeaters, there would be no amateur radio in the Illawarra. Our services are available to all, even the Propagator which is published on the Internet.

Little things start a revolution, great things start from something small. Encourage hams and others to join their local club, the local club is the heartbeat of our hobby. The local club is the centre for meeting, greeting and sharing with someone you know and can shake their hand. You can ask for assistance from someone you have met, friendships develop and acquaintances renewed. Your voice and opinion actually mean something and you have a say in what happens in your local club.

To all those who have long arms and deep pockets, thank you for keeping our local club operational into the future. The Foundation Licence is to encourage our hobby but if our local club collapses, what will happen to them and to other hams in the Illawarra if our Club goes the way of others and folds because of lack of interest, membership and finances in our local Club to keep us going?

Let's keep our Club strong and healthy and make a stand for the individual – the building block of society and our hobby. Join a local Club were everyone actually does count in the scheme of our hobby.

Maeva Bennett
VK2HUG

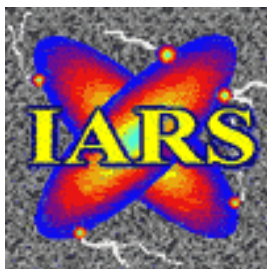

ILLAWARRA AMATEUR RADIO SOCIETY (INC)

Minutes of November 8th 2005

Attendance: As per Attendance Book

Appologies: Rob Heyer VK2XIC
Frank Diggle SWL

Visitors: Wal and Lyn Kelly

Meeting opened by President Tony Stone VK2TS at 7.40pm

Minutes from October meeting read and accepted.

Business Arising Nil

Correspondence In

- IMB
- Agenda for Conference of Clubs

Treasurer's Report

Tres. John Lawler VK2KEJ Financial report read and accepted as true record of club finances.
IMB investment matured, money reinvested until 2/5/06 at 5.55%

Repeater Report

All seems to be working OK.

IRLP

IRLP Node 6018 is on air and available for use. Don't forget your preamble before attempting to dial your DTMF tones and the same goes when disconnecting.

General Business

1. 2006 Call books from WIA, need to be ordered by members individually
2. Certificate Information for December presentations
3. Foundation Licence, applications and examinations have not be requested as yet
4. Christmas meeting – members to bring a plate

There being no further business the meeting closed at 7.47pm pm.

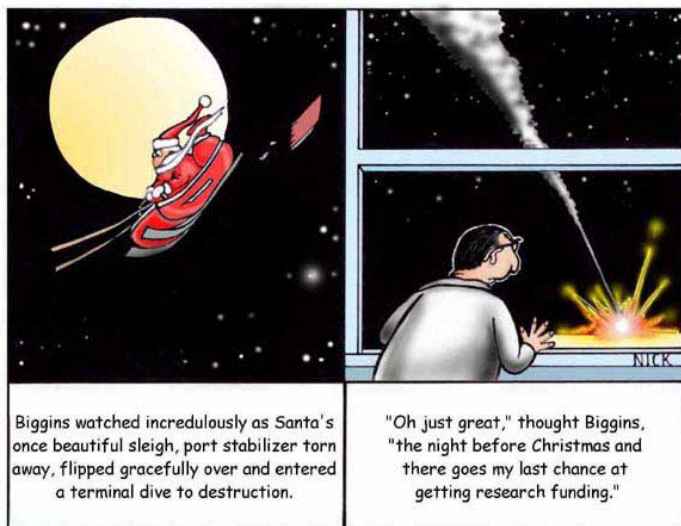

About the Airwaves.

- Ted Thrift is not feeling the best at the moment. Could all members please refrain from calling him on the phone until he's feeling better. Get well soon Ted.
- A few of our members have new call signs with the change of licencing.
Brian Farrar VK2UB is now VK2AH
Tom Burt VK2YOS is now VK2TB
If you have changed your call sign, please let us know, so we can broadcast your new ID.
- Don't forget the Wyong Field Day on the 19th February, 2006. Please remind your partner if they wish to participate in the Crafty Ladies Section, booking/reservations are required for the craft workshops.

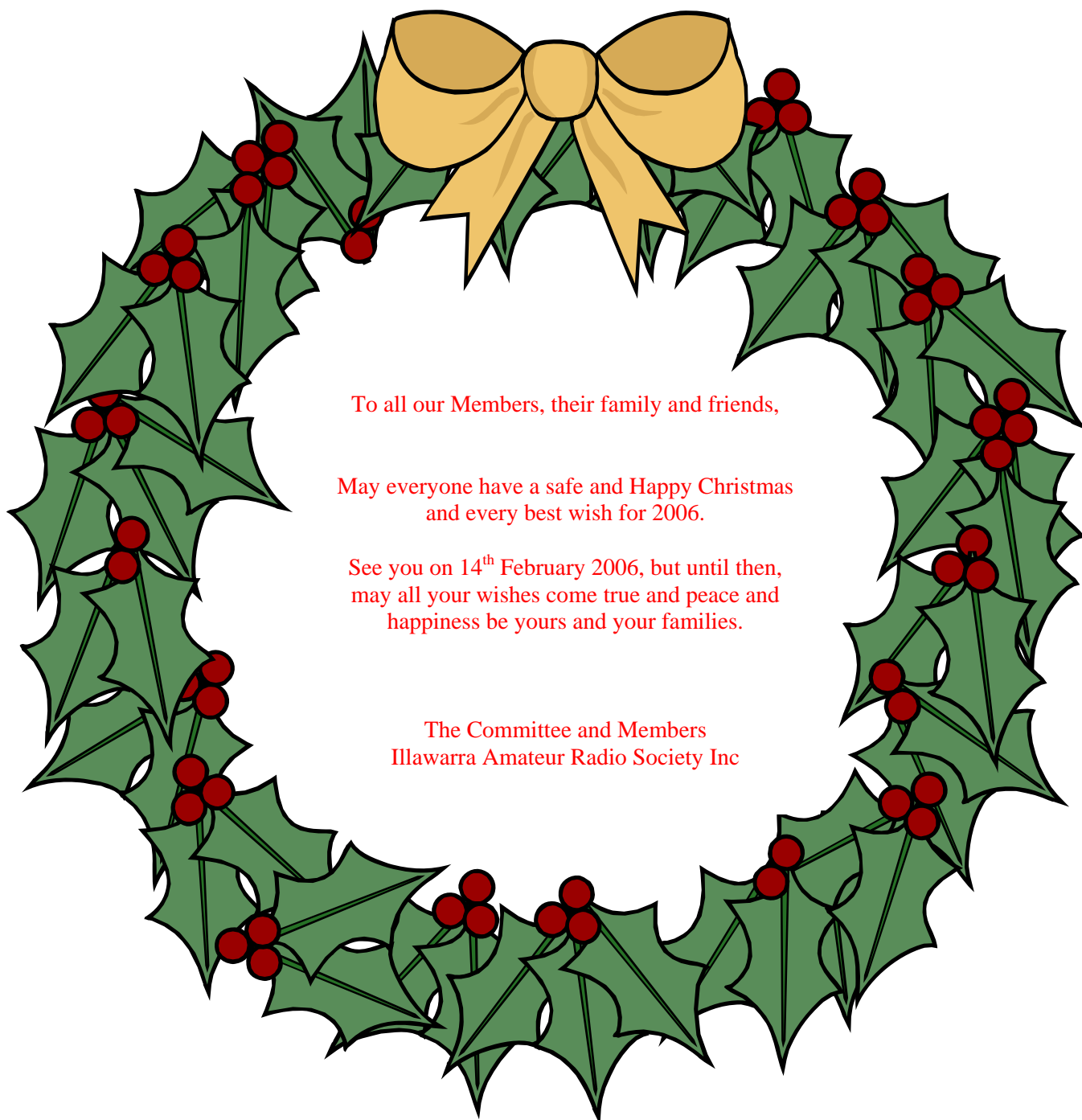

To all our Members, their family and friends,

May everyone have a safe and Happy Christmas
and every best wish for 2006.

See you on 14th February 2006, but until then,
may all your wishes come true and peace and
happiness be yours and your families.

The Committee and Members
Illawarra Amateur Radio Society Inc